

Art. Nr. 2847296  
1/7



01.02.2024

Art. Nr. 2847296

Groundplan - Grundplan - Plan de masse - Planimetria - Plattegrond - Põhiplaan

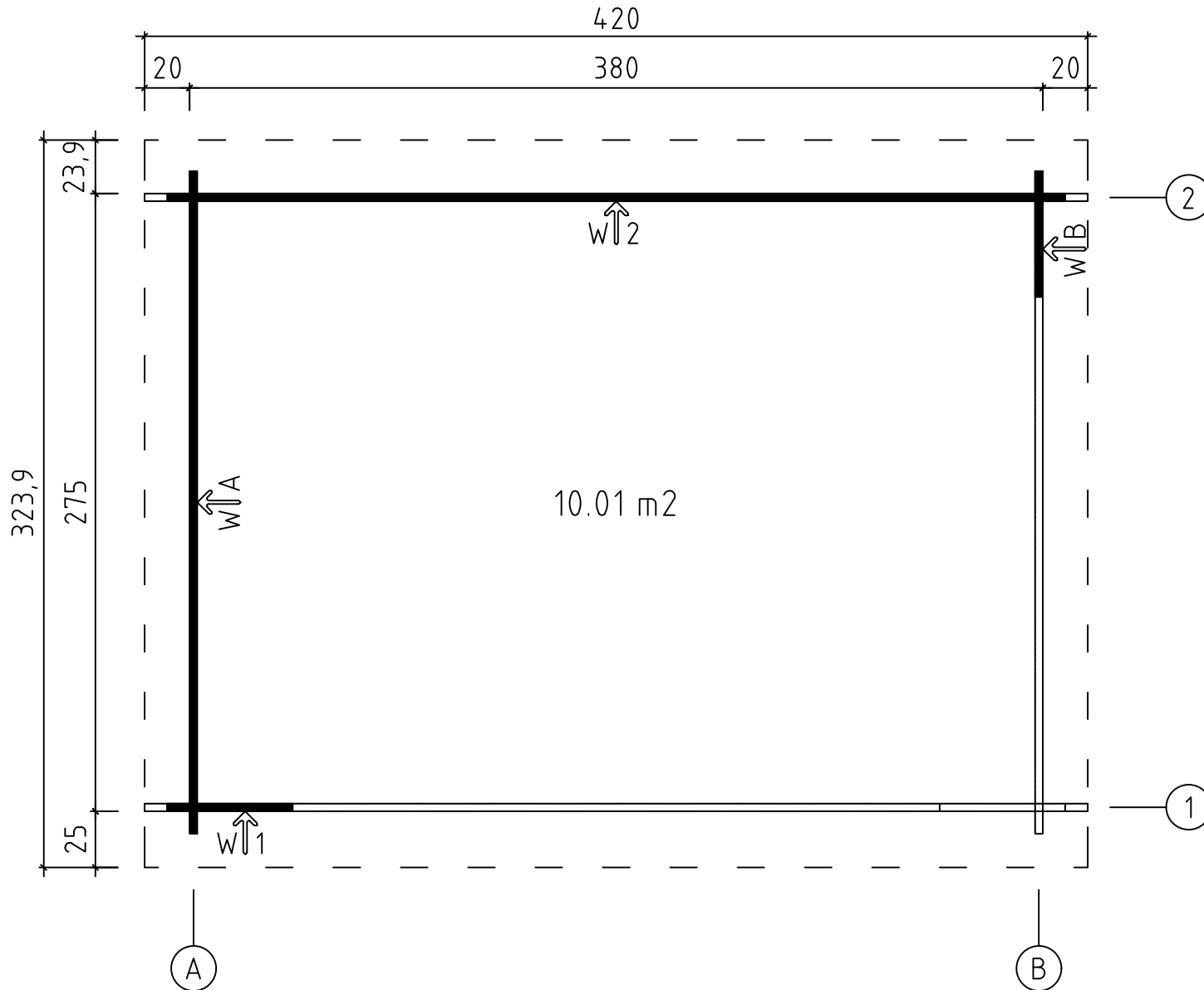





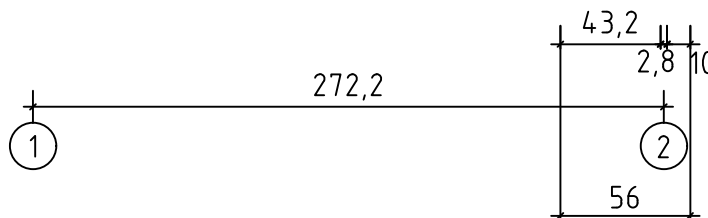
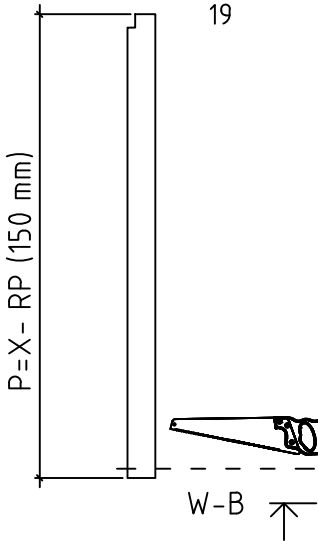
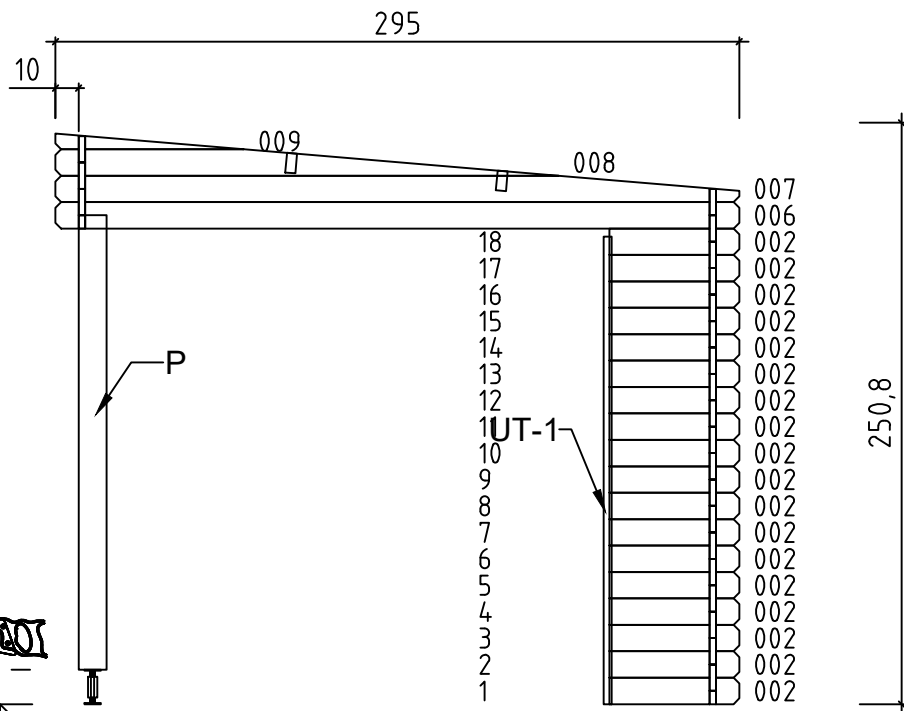
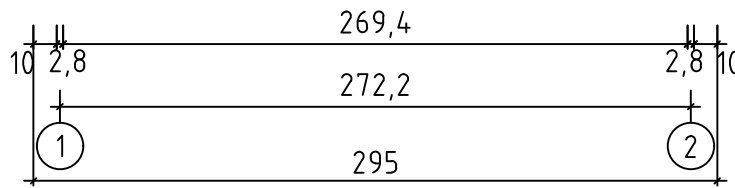
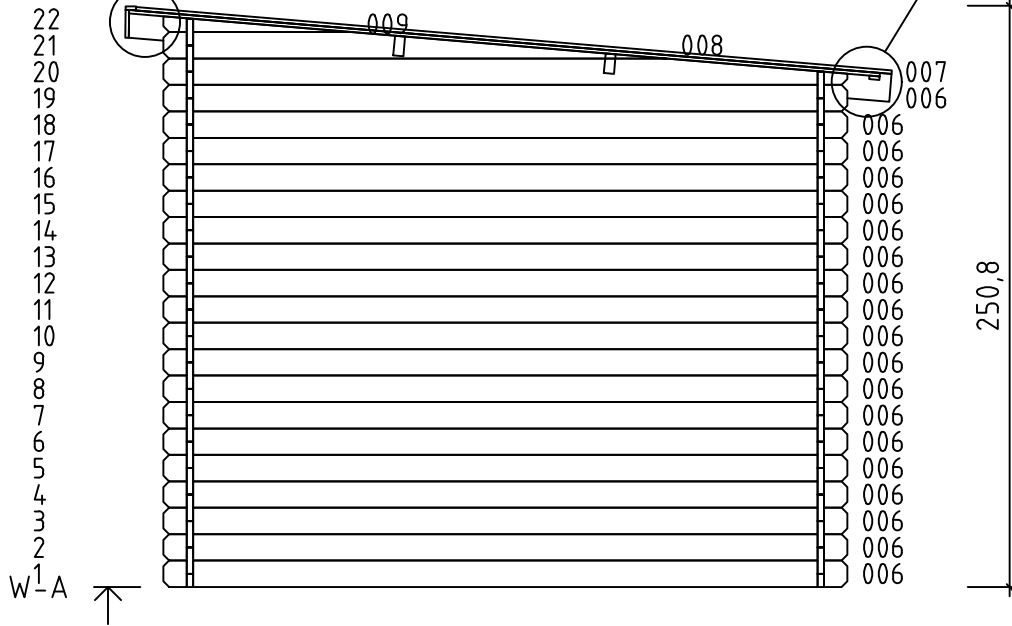
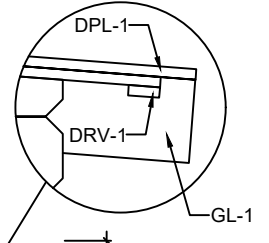
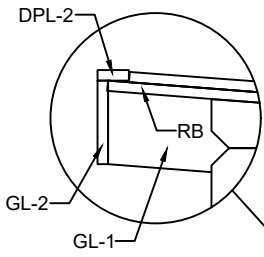

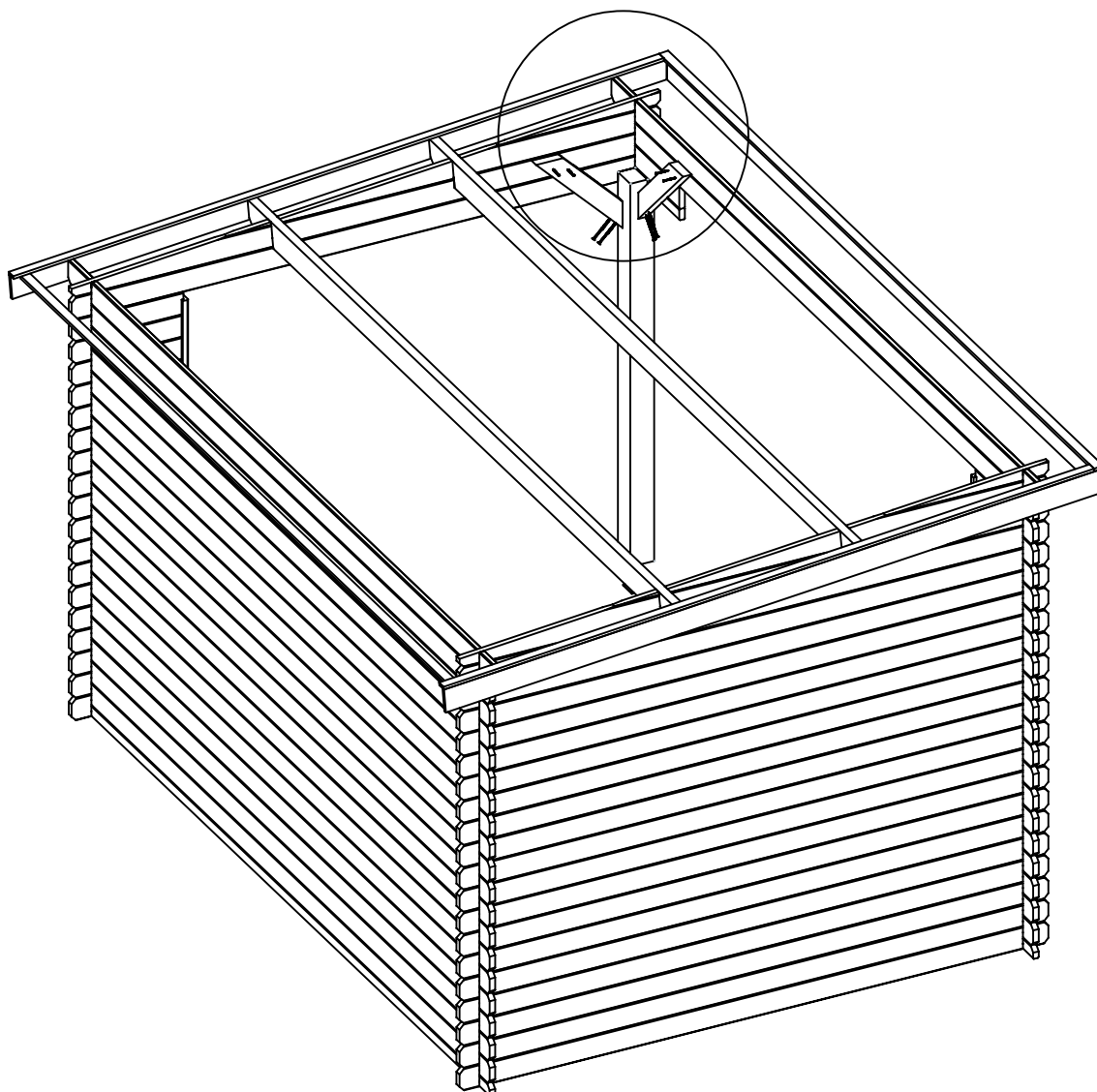
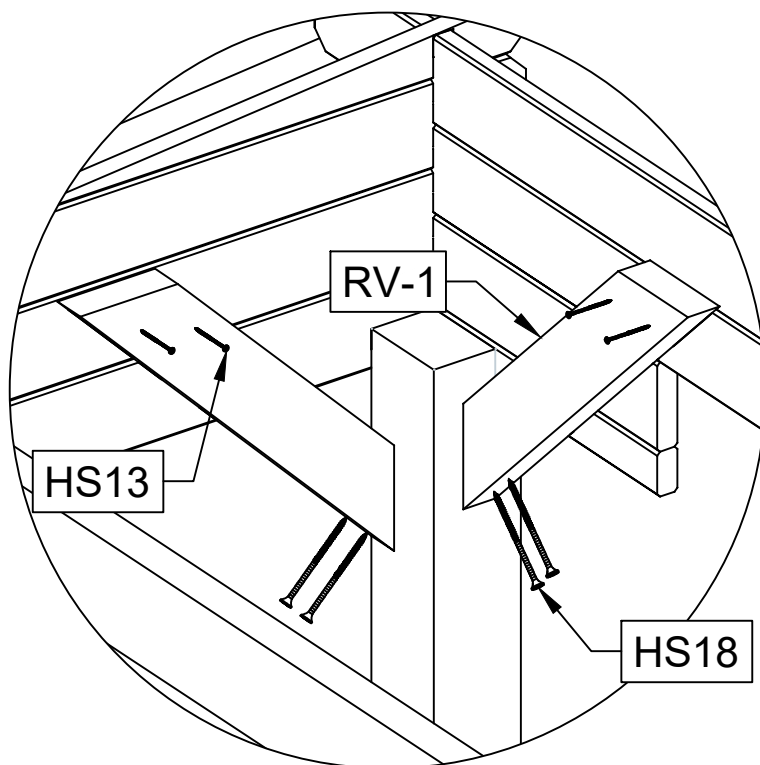



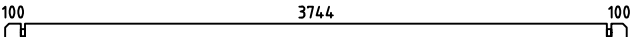
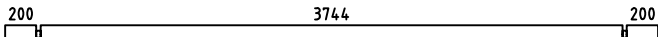
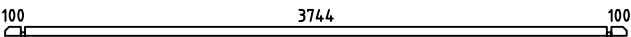
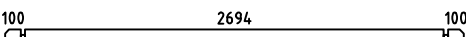
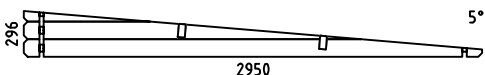
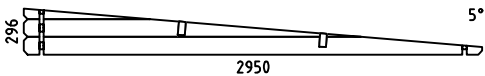
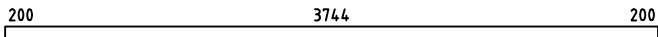
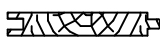

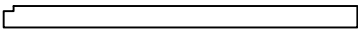

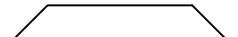
Art. Nr. 2847296





Pos	01.02.2024 Piece list - Stückliste - Liste des pièces - Elementi - Stuklijst - Elementos - Tükítabel Art. Nr. 2847296	6/7	Q	P (mm)	L (mm)
001 39463			2	28x57	560
002 39464			38	28x114	560
003 17110			19	28x114	4000
004 37478			2	28x114	4200
005 21407			1	28x57	4000
006 10854			20	28x114	2950
WA-1 39465			1		
WB-1 39465			1		
A-PR1 35092	Roof beam - Dachbalken - Panne de toit - Perlina del tetto - Gordingen / dakbalk - Correa - Pärlin 		2	44x146	4200
RB 39466	Roof boards - Dachbretter - Voliges - Perlina per tetto - Dakhout - Tablero de tejado - Katuselaud 		47	90x15.5	3250
DPL-1 39467	Roofing felt fillet - Dachpappenleiste - Baguette de fixation du feutre bitumeux - Asse per fissaggio guaina bituminosa - Afdeklijst asfaltpapier - Moldura de fieltro para tejado - Katusepapiilist 		2	15x45	3270
DPL-2 39484	Roofing felt fillet - Dachpappenleiste - Baguette de fixation du feutre bitumeux - Asse per fissaggio guaina bituminosa - Afdeklijst asfaltpapier - Moldura de fieltro para tejado - Katusepapiilist 		1	15x45	4230
P 39468	Post - Pfosten - Poteau - Piede registrabile - Stijl - Poste - Post 		1	120x120	2000
DRV-1 26490	Roof edge reinforcement - Dachrandverstärkung - Corniere de renfort de bord de toit - Rinforzo x tetto - Dakrand versterking - Refuerzo de aleros - Räästafugevdus 		1	15x45	4200
RV-1 34799	Beam - Balkenlage - Solive(s) - Trave - Balk (gording) - Viga - Tala 		2	44x120	620
KFS-1 27180	Storm protection - Sturmleiste - Latte anti-tempete - Protezione anti vento - Stormverankering / beveliging - Moldura antitormenta - Tornikinnitusliist 		3	22x45	2500
UT-1 35094	U-profile - U-profils - Profile u - Profilo ad u - U-profiel - Perfil en U - U-profiil 		1	28x58	2017
UT-2 35095	U-profile - U-profils - Profile u - Profilo ad u - U-profiel - Perfil en U - U-profiil 		1	28x58	2190
GL-1 39469	Gable moulding - Giebelleiste - Planche de rive - Finitura per frontale e retro del tetto - Gevellijst - Tablero de frontón - Viilulaud 		2	15x120	3300
GL-2 32852	Gable moulding - Giebelleiste - Planche de rive - Finitura per frontale e retro del tetto - Gevellijst - Tablero de frontón - Viilulaud 		1	15x120	4230
HS9 5106	Screw for u-profile - Schraube zur befestigung u-profils - Vis a tete fraisée pour profil u - Vite per profilo ad u - Schroef ter bevestiging u-profiel - Tornillo para perfil en U - Kruvi U-profiilite 		12	3.5x50	

